



# **Operator's Manual**

---

**AT, MT, HT Series  
On-Highway Transmissions**

OM1334EN

# Operator's Manual

## Allison Transmission

AT 540

AT 542(N)(R)(NFE)

AT 543

AT 545(N)(R)

AT 1542P

AT 1545P(N)

MT 640, MT(B) 643, MT 643R, 644, 647

MT 650, MT(B) 653, 654CR

HT 740(D)(RS)(FS)

HT 747(D)

HT 750CRD, HT 750DR (DB)(RS)

HT 750DRI, HT 750DRD (DB)

HT 754CRD, HT 754CR (RS)



**Allison Transmission**  
Division of General Motors Corporation  
P.O. Box 894 Indianapolis, Indiana 46206-0894

July, 1997  
Revision 2 20000501

## WARNINGS, CAUTIONS, AND NOTES

IT IS YOUR RESPONSIBILITY to be completely familiar with the warnings and cautions described in this handbook. It is, however, important to understand that these warnings and cautions are not exhaustive. Allison Transmission could not possibly know, evaluate, and advise the service trade of all conceivable ways in which service might be done or of the possible hazardous consequences of each way. Consequently, Allison Transmission has not undertaken any such broad evaluation. Accordingly, ANYONE WHO USES A SERVICE PROCEDURE OR TOOL WHICH IS NOT RECOMMENDED BY ALLISON TRANSMISSION MUST first be thoroughly satisfied that neither personal safety nor equipment safety will be jeopardized by the service methods selected.

Proper service and repair is important to the safe, reliable operation of the equipment. The service procedures recommended by Allison Transmission and described in this handbook are effective methods for performing service operations. Some of these service operations require the use of tools specially designed for the purpose. The special tools should be used when and as recommended.

Three types of headings are used in this manual to attract your attention. These warnings and cautions advise of specific methods or actions that can result in personal injury, damage to the equipment, or cause the equipment to become unsafe.



**WARNING:** A warning is used when an operating procedure, practice, etc., if not correctly followed, could result in personal injury or loss of life.



**CAUTION:** A caution is used when an operating procedure, practice, etc., if not strictly observed, could result in damage to or destruction of equipment.



**NOTE:** A note is used when an operating procedure, practice, etc., is essential to highlight.

## TRADEMARK INFORMATION

DEXRON<sup>®</sup> is a registered trademark of General Motors Corporation.

# TABLE OF CONTENTS

Page

## INTRODUCTION

Warnings, Cautions, And Notes . . . . .	ii
Keeping That Allison Advantage . . . . .	1
Typical AT, MT, And HT Model Transmissions . . . . .	2
A Brief Description Of The Allison Automatic . . . . .	3
Torque Converter . . . . .	3
Lockup Clutch (AT 1500, MT(B) 600, HT 700) . . . . .	3

## SHIFT SELECTORS

Allison Automatics . . . . .	6
Typical AT, MT, HT Shift Selector Positions . . . . .	6
Range Selection — AT 500 Series And AT 1500 Series With A Second Neutral (Park) . . . . .	7
Range Selection — AT 500 Series And AT 1500 Series Without A Second Neutral (Park); MT 640, MT(B) 643, MT 643R, MT(B) 644, MT 647; HT 740, HT 747. . . . .	9
Range Selection — MT 650; MT(B) 653DR. . . . .	11
Range Selection — HT 750CR, HT 754CR, MT(B) 654CR. . . . .	13
Range Selection — HT 750DR, HT 750DR DB . . . . .	15

## DRIVING TIPS

Throttle Control . . . . .	17
Downshift Inhibit Feature. . . . .	17
Operating In Cold Weather. . . . .	17
Using the Engine For Downhill Braking To Slow The Vehicle Or Equipment. . . . .	18
Using The Hydraulic Retarder . . . . .	18
Auxiliary Transmission. . . . .	20
Two-Speed Axle . . . . .	20
Towing Or Pushing. . . . .	20
Parking Brake . . . . .	20
Driving On Ice Or Snow. . . . .	21
Rocking Out . . . . .	21
Temperatures. . . . .	21

## POWER TAKEOFF OPERATION

Engine-Driven PTO .....	23
Converter-Driven PTO .....	23

## CARE AND MAINTENANCE

Periodic Inspections .....	25
Prevent Major Problems .....	26
Importance Of Proper Fluid Level .....	26
Transmission Fluid Check Procedure .....	27
Cold Check .....	28
Hot Check .....	29
Dropbox Fluid Check Procedure .....	29
Keeping Fluid Clean .....	30
Recommended Automatic Transmission Fluid And Viscosity Grade Non-MT 643R Transmissions .....	30
Recommended Automatic Transmission Fluid And Viscosity Grade MT 643R Transmissions .....	31
Fluid And Filter Change Intervals .....	32
Fluid Contamination .....	33
Auxiliary Filter .....	35

## CUSTOMER SERVICE

Owner Assistance .....	36
Service Literature .....	38
Allison Transmission Distributors .....	39
Allison Transmission Regional Offices .....	42

# INTRODUCTION



## KEEPING THAT ALLISON ADVANTAGE



V01724

Allison automatics provide many advantages for the driver who must “stop and go” or change speeds frequently. Driving is easier, safer, and more efficient.

These automatics are rugged and are designed to provide long, trouble-free service. This handbook will help you gain maximum benefits from your Allison-equipped vehicle.

# TYPICAL AT, MT, AND HT MODEL TRANSMISSIONS

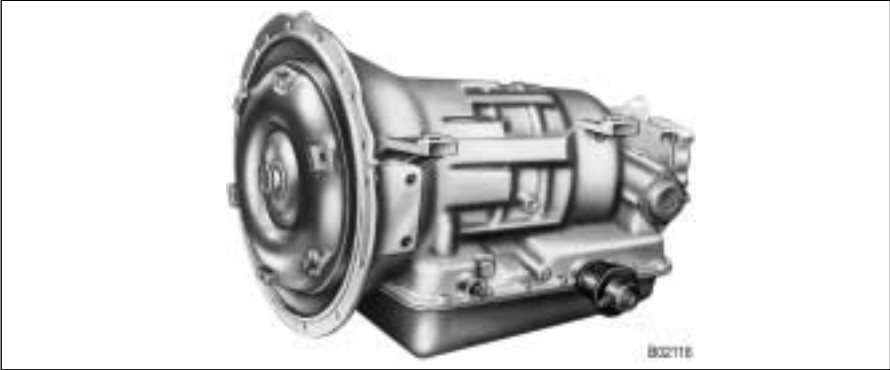

**AT Model Transmission**



**MT Model Transmission**



**HT Model Transmission**

# **A BRIEF DESCRIPTION OF THE ALLISON AUTOMATIC**

Allison automatics described in this manual include a hydraulic torque converter, a planetary gear train, and a hydraulic control system which supplies fluid under pressure to apply the clutches and automatically shift ranges.

The torque converter multiplies engine torque during starts and acts as a hydraulic cushion between the engine and gearing. The clutches and gear sets provide multiple speeds forward and one speed reverse.

The torque converter lockup clutch, for maximum fuel economy, engages automatically after the vehicle is moving. All models in this manual, except AT 500, have a lockup clutch.

## **TORQUE CONVERTER**

The torque converter consists of three elements — pump, turbine, and stator. The pump is the input element and is driven by the engine. The turbine is the output element and is driven by fluid from the pump, or directly by the pump when the lockup clutch is engaged. The stator is the reaction (torque multiplying) element.

The torque converter is continuously filled with fluid. The pump, driven by the engine, directs the fluid against the turbine vanes, which causes the turbine to rotate. The turbine returns the fluid through the stator, which redirects the flow so that fluid strikes the pump vanes in the same direction that the pump is rotating. As the pump turns faster in relation to the turbine, the velocity of the fluid increases and so does the torque multiplication.

As the speed of the turbine approaches the speed of the pump, the fluid flow starts striking the back sides of the stator vanes. This causes the stator to freewheel in the same direction as the pump and turbine. When this occurs, the torque multiplication stops and the converter functions as a fluid coupling.

## **LOCKUP CLUTCH (AT 1500, MT(B) 600, HT 700)**

The lockup clutch consists of three elements — piston, clutch plate, and backplate. The piston and backplate are driven by the engine. The clutch plate, located between the piston and backplate, is splined to the converter turbine.

The lockup clutch automatically engages after the vehicle is moving and the torque multiplication demand is low. Engagement of the lockup clutch mechanically connects the torque converter pump to the turbine and provides a direct drive from the engine to the transmission. The lockup clutch automatically releases at lower vehicle speeds. When the lockup clutch is not engaged, drive from the engine is transmitted hydraulically through the converter to the transmission gearing.



Because the converter lockup engagement and release are designed to fit the vehicle's vocation, there are many variations among transmission assemblies. Lockup speeds are determined by many factors. Among these are transmission-engine match, transmission-vehicle match, model year, throttle position, and calibration of the hydraulic system. Some models have lockup available in all ranges. Others have lockup available in the upper ranges. Some models have modulated lockup, which provides better engine braking by delaying lockup disengagement during closed-throttle operation. For specific information on the lockup characteristics of your transmission, contact your dealer or distributor.

Lockup engagement, like range shifts, may be felt under some conditions. The driver who counts shifts should not confuse lockup with a range change. A little driving experience with the Allison automatic will enable the driver to distinguish between the two kinds of shifts.

# SHIFT SELECTORS



The vehicle manufacturers may choose different types of shift selectors for their equipment. Different transmission models may also require different designations on the shift selectors.

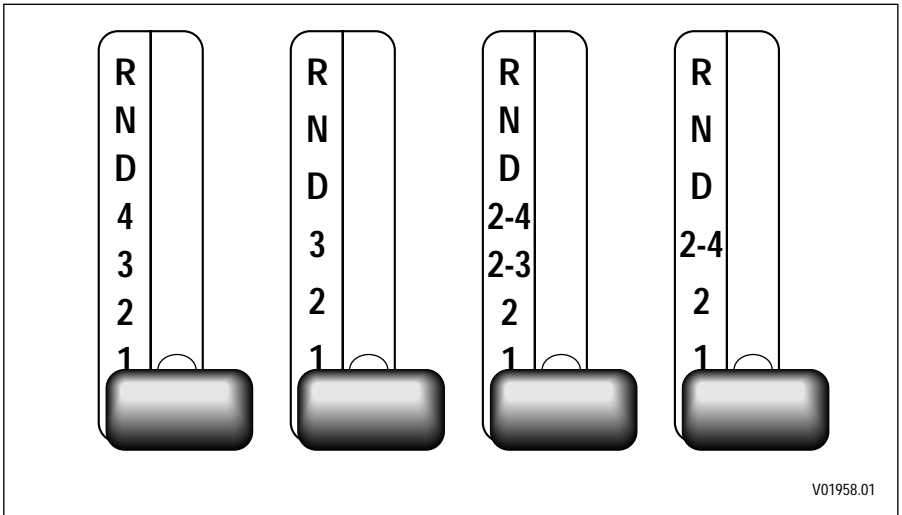

**Typical Shift Selector Labeling**

These are some of the typical shift selectors you may find in Allison-equipped vehicles. The range selector in your vehicle may vary from these or may have **1** (First Range) at the top and **R** (Reverse) at the bottom. Some models may have a **P** (Park) position.

The best performance will be obtained by using the correct range for each driving condition. The following table illustrates shift patterns for the various models and indicates the page that explains the shift pattern for your vehicle.

# ALLISON AUTOMATICS

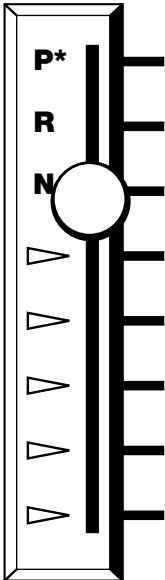

	AT 500 Series And AT 1500 Series	MT 640, MT(B) 643, MT 643R, MT(B) 644◇, MT(B) 647	MT 650, MT(B) 653DR	HT 740, HT 747	HT 750CR, HT 754CR, MT(B) 654CR◇	HT 750DR (DR DB)
P*	Park	—	—	—	—	—
R	Reverse	Reverse	Reverse	Reverse	Reverse	Reverse
N	Neutral	Neutral	Neutral	Neutral	Neutral	Neutral
▽	1-4	1-4	2-5	1-4	1-5	2-5
▽	1-3	1-3	2-4	1-3	1-4	2-4
▽	1-2+	1-2	2 (2-3**)	1-2	1-3	2-3
▽	1	1	1	1	1-2	2
▽	—	—	—	—	1	1
	(Pages 7-10)	(Pages 9-10)	(Pages 11-12)	(Pages 9-10)	(Pages 13-14)	(Pages 15-16)

V01959

## Typical AT, MT, HT Shift Selector Positions

When your vehicle is equipped with an Allison automatic, it is not necessary to select the right moment to upshift or downshift during the changing road and traffic conditions. The Allison automatic does it for you. A knowledge of the ranges available at your shift selector will make control of the vehicle and your job even easier.

When the shift selector has no **P** (Park) provision, always put the selector in **N** (Neutral) and apply the parking brake (or service brakes if the vehicle is not equipped with a parking brake) to hold the vehicle when it is unattended and before turning off the engine.



\* Available on AT 500 Series and AT 1500 Series models *only* (refer to Page 7).

+ This position not present on models with **P** (Park).

\*\* Optional.

◇ Without second gear start.



# RANGE SELECTION — AT 500 SERIES AND AT 1500 SERIES WITH A SECOND NEUTRAL (PARK)

	<p><b>WARNING:</b> If you leave the vehicle and the engine is running, the vehicle can move suddenly and you or others could be injured. If you must leave the engine running, do not leave the vehicle until you:</p> <ul style="list-style-type: none"> <li>• Put the transmission in <b>N</b> (Neutral)...and</li> <li>• Apply the parking brake and emergency brakes and make sure they are properly engaged...and</li> <li>• Chock the wheels and take any other steps necessary to keep the vehicle from moving.</li> </ul>
<p><b>P</b></p>	<p>This activates the vehicle parking brake and at the same time puts the transmission in neutral. Use this position when you start the engine. If the engine starts in any other position, except <b>N</b> (Neutral), the neutral start switch is malfunctioning.</p>
<p><b>R</b></p>	<p>Use this to back the vehicle. Completely stop the vehicle before shifting from a forward range to <b>R</b> (Reverse) or from <b>R</b> (Reverse) to a forward range. The reverse warning signal is activated when the shift selector is in this position. Reverse has only one range. Reverse operation also provides the greatest tractive advantage.</p>
	<p><b>WARNING:</b> If you let the vehicle coast in <b>N</b> (Neutral), there is no engine braking and you could lose control. Coasting can also cause severe transmission damage. To help avoid injury and property damage, do not allow the vehicle to coast in <b>N</b> (Neutral).</p>
<p><b>N</b></p>	<p>Neutral position is used during stationary operation of the power takeoff (if your vehicle is equipped with a PTO).</p>
<p><b>D</b></p>	<p>The transmission will initially attain 1st range and, as vehicle speed increases, the transmission will upshift to 2nd range, 3rd range, and 4th range automatically. As the vehicle slows down, the transmission will downshift to the correct range automatically.</p>
	<p><b>WARNING:</b> If you just downshift or just use service brakes when going downhill, you can lose control and cause injury and property damage. To help avoid loss of control, use a combination of downshifting, braking, and other retarding devices. Downshifting to a lower transmission range increases engine braking and helps you to maintain control. The transmission has a feature to prevent automatic upshifting above the lower range selected. However, during downhill operation, if engine governed speed is exceeded in the lower range, the transmission may upshift to the next higher range. This will reduce braking and could cause a loss of control. Apply the vehicle brakes or other retarding device to prevent exceeding engine governed speed in the lower range selected.</p>

**RANGE SELECTION — AT 500 SERIES AND AT 1500 SERIES WITH A SECOND NEUTRAL (PARK) *(cont'd)***

<p><b>3</b></p> <p><b>2</b></p>	<p>Occasionally, the road, load, or traffic conditions will make it desirable to restrict the automatic shifting to a lower range. (When conditions improve, return the selector to the normal <b>D</b> (Drive) position.) These positions also provide greater engine braking for going down grades (the lower the range, the greater the braking effect).</p>
<p><b>1</b></p>	<p>Use this range when pulling through mud and snow or driving up or down steep grades. This range provides the vehicle with maximum driving power and maximum engine braking power.</p>



**RANGE SELECTION — AT 500 SERIES AND AT 1500 SERIES WITHOUT A SECOND NEUTRAL (PARK); MT 640, MT(B) 643, MT 643R, MT(B) 644, MT 647; HT 740, HT 747**

	<p><b>WARNING:</b> If you leave the vehicle and the engine is running, the vehicle can move suddenly and you or others could be injured. If you must leave the engine running, do not leave the vehicle until you:</p> <ul style="list-style-type: none"> <li>• Put the transmission in <b>N</b> (Neutral)...and</li> <li>• Apply the parking brake and emergency brakes and make sure they are properly engaged...and</li> <li>• Chock the wheels and take any other steps necessary to keep the vehicle from moving.</li> </ul>
<p><b>R</b></p>	<p>Use this to back the vehicle. Completely stop the vehicle before shifting from a forward range to <b>R</b> (Reverse) or from <b>R</b> (Reverse) to a forward range. The reverse warning signal is activated when the shift selector is in this position. Reverse has only one range. Reverse operation also provides the greatest tractive advantage.</p>
	<p><b>WARNING:</b> If you let the vehicle coast in <b>N</b> (Neutral), there is no engine braking and you could lose control. Coasting can also cause severe transmission damage. To help avoid injury and property damage, do not allow the vehicle to coast in <b>N</b> (Neutral).</p>
<p><b>N</b></p>	<p>Use this position when you start the engine. If the engine starts in any other position, the neutral start switch is malfunctioning. Neutral position is also used during stationary operation of the power takeoff (if your vehicle is equipped with a PTO).</p>
<p><b>D</b></p>	<p>The transmission will initially attain 1st range and, as vehicle speed increases, the transmission will upshift to 2nd range, 3rd range, and 4th range automatically. As the vehicle slows down, the transmission will downshift to the correct range automatically.</p>
	<p><b>WARNING:</b> If you just downshift or just use service brakes when going downhill, you can lose control and cause injury and property damage. To help avoid loss of control, use a combination of downshifting, braking, and other retarding devices. Downshifting to a lower transmission range increases engine braking and helps you to maintain control. The transmission has a feature to prevent automatic upshifting above the lower range selected. However, during downhill operation, if engine governed speed is exceeded in the lower range, the transmission may upshift to the next higher range. This will reduce braking and could cause a loss of control. Apply the vehicle brakes or other retarding device to prevent exceeding engine governed speed in the lower range selected.</p>

**RANGE SELECTION — AT 500 SERIES AND AT 1500 SERIES WITHOUT A SECOND NEUTRAL (PARK); MT 640, MT(B) 643, MT 643R, MT(B) 644, MT 647; HT 740, HT 747 (cont'd)**

<p><b>3</b> <b>2</b></p>	<p>Occasionally, the road, load, or traffic conditions will make it desirable to restrict the automatic shifting to a lower range. (When conditions improve, return the selector to the normal <b>D</b> (Drive) position.) These positions also provide greater engine braking for going down grades (the lower the range, the greater the braking effect).</p>
<p><b>1</b></p>	<p>Use this range when pulling through mud and snow or driving up or down steep grades. This range provides the vehicle with maximum driving power and maximum engine braking power.</p>

## RANGE SELECTION — MT 650; MT(B) 653DR



	<p><b>WARNING:</b> If you leave the vehicle and the engine is running, the vehicle can move suddenly and you or others could be injured. If you must leave the engine running, do not leave the vehicle until you:</p> <ul style="list-style-type: none"> <li>• Put the transmission in <b>N</b> (Neutral)...and</li> <li>• Apply the parking brake and emergency brakes and make sure they are properly engaged...and</li> <li>• Chock the wheels and take any other steps necessary to keep the vehicle from moving.</li> </ul>
<p><b>R</b></p>	<p>Use this to back the vehicle. Completely stop the vehicle before shifting from a forward range to <b>R</b> (Reverse) or from <b>R</b> (Reverse) to a forward range. The reverse warning signal is activated when the shift selector is in this position. Reverse has only one range.</p>
	<p><b>WARNING:</b> If you let the vehicle coast in <b>N</b> (Neutral), there is no engine braking and you could lose control. Coasting can also cause severe transmission damage. To help avoid injury and property damage, do not allow the vehicle to coast in <b>N</b> (Neutral).</p>
<p><b>N</b></p>	<p>Use this position when you start the engine. If the engine starts in any other position, the neutral start switch is malfunctioning. Neutral position is also used during stationary operation of the power takeoff (if your vehicle is equipped with a PTO).</p>
<p>2–5 <b>D</b></p>	<p>The transmission will initially attain 2nd range and, as vehicle speed increases, the transmission will upshift to 3rd range, 4th range, and 5th range automatically. As the vehicle slows down, the transmission will downshift to the correct range automatically.</p>
	<p><b>WARNING:</b> If you just downshift or just use service brakes when going downhill, you can lose control and cause injury and property damage. To help avoid loss of control, use a combination of downshifting, braking, and other retarding devices. Downshifting to a lower transmission range increases engine braking and helps you to maintain control. The transmission has a feature to prevent automatic upshifting above the lower range selected. However, during downhill operation, if engine governed speed is exceeded in the lower range, the transmission may upshift to the next higher range. This will reduce braking and could cause a loss of control. Apply the vehicle brakes or other retarding device to prevent exceeding engine governed speed in the lower range selected.</p>
<p>2–4</p>	<p>Occasionally, the road, load, or traffic conditions will make it desirable to restrict the automatic shifting to a lower range. (When conditions improve, return the selector to the normal <b>D</b> (Drive) position.)</p>



**RANGE SELECTION — MT 650; MT(B) 653DR (cont'd)**

<p><b>2</b> <b>2-3</b></p>	<p>Use this position for vehicle speed control up or down steep grades or for other undesirable driving conditions.</p>
<p><b>1</b></p>	<p>This is the creeper range — select this for off-highway operation. Use the creeper for pulling through mud or snow. This range provides the greatest tractive advantage. It is not recommended that full-power 1-2 or 2-1 shifts be made.</p>



# RANGE SELECTION — HT 750CR, HT 754CR, MT(B) 654CR

	<p><b>WARNING:</b> If you leave the vehicle and the engine is running, the vehicle can move suddenly and you or others could be injured. If you must leave the engine running, do not leave the vehicle until you:</p> <ul style="list-style-type: none"> <li>• Put the transmission in <b>N</b> (Neutral)...and</li> <li>• Apply the parking brake and emergency brakes and make sure they are properly engaged...and</li> <li>• Chock the wheels and take any other steps necessary to keep the vehicle from moving.</li> </ul>
<p style="text-align: center;"><b>R</b></p>	<p>Use this to back the vehicle. Completely stop the vehicle before shifting from a forward range to <b>R</b> (Reverse) or from <b>R</b> (Reverse) to a forward range. The reverse warning signal is activated when the shift selector is in this position. Reverse operation provides the greatest tractive advantage. Reverse has only one range.</p>
	<p><b>WARNING:</b> If you let the vehicle coast in <b>N</b> (Neutral), there is no engine braking and you could lose control. Coasting can also cause severe transmission damage. To help avoid injury and property damage, do not allow the vehicle to coast in <b>N</b> (Neutral).</p>
<p style="text-align: center;"><b>N</b></p>	<p>Use this position when you start the engine. If the engine starts in any other position, the neutral start switch is malfunctioning. Neutral position is also used during stationary operation of the power takeoff (if your vehicle is equipped with a PTO).</p>
<p style="text-align: center;"><b>D</b></p>	<p>The transmission will initially attain 1st range and, as vehicle speed increases, the transmission will upshift to 2nd range, 3rd range, 4th range, and 5th range automatically. As the vehicle slows down, the transmission will downshift to the correct range automatically.</p>
	<p><b>WARNING:</b> If you just downshift or just use service brakes when going downhill, you can lose control and cause injury and property damage. To help avoid loss of control, use a combination of downshifting, braking, and other retarding devices. Downshifting to a lower transmission range increases engine braking and helps you to maintain control. The transmission has a feature to prevent automatic upshifting above the lower range selected. However, during downhill operation, if engine governed speed is exceeded in the lower range, the transmission may upshift to the next higher range. This will reduce braking and could cause a loss of control. Apply the vehicle brakes or other retarding device to prevent exceeding engine governed speed in the lower range selected.</p>

**RANGE SELECTION — HT 750CR, HT 754CR, MT(B) 654CR**  
*(cont'd)*

<p><b>4</b></p> <p><b>3</b></p> <p><b>2</b></p>	<p>Occasionally, the road, load, or traffic conditions will make it desirable to restrict the automatic shifting to a lower range. (When conditions improve, return the selector to the normal <b>D</b> (Drive) position.) The positions also provide a greater engine braking for going down grades (the lower the range, the greater the braking effect).</p>
<p><b>1</b></p>	<p>Use this range when pulling through mud and snow or driving up or down steep grades. This range provides the vehicle with maximum driving power and maximum engine braking power.</p>

# RANGE SELECTION — HT 750DR, HT 750DR DB

	<p><b>WARNING:</b> If you leave the vehicle and the engine is running, the vehicle can move suddenly and you or others could be injured. If you must leave the engine running, do not leave the vehicle until you:</p> <ul style="list-style-type: none"> <li>• Put the transmission in <b>N</b> (Neutral)...and</li> <li>• Apply the parking brake and emergency brakes and make sure they are properly engaged...and</li> <li>• Chock the wheels and take any other steps necessary to keep the vehicle from moving.</li> </ul>
<b>R</b>	<p>Use this to back the vehicle. Completely stop the vehicle before shifting from a forward range to <b>R</b> (Reverse) or from <b>R</b> (Reverse) to a forward range. The reverse warning signal is activated when the shift selector is in this position. Reverse operation provides the greatest tractive advantage. Reverse has only one range.</p>
	<p><b>WARNING:</b> If you let the vehicle coast in <b>N</b> (Neutral), there is no engine braking and you could lose control. Coasting can also cause severe transmission damage. To help avoid injury and property damage, do not allow the vehicle to coast in <b>N</b> (Neutral).</p>
<b>N</b>	<p>Use this position when you start the engine. If the engine starts in any other position, the neutral start switch is malfunctioning. Neutral position is also used during stationary operation of the power takeoff (if your vehicle is equipped with a PTO).</p>
<b>2-5</b>	<p>The transmission will initially attain 2nd range and, as vehicle speed increases, the transmission will upshift to 3rd range, 4th range, and 5th range automatically. As the vehicle slows down, the transmission will downshift to the correct range automatically.</p>
	<p><b>WARNING:</b> If you just downshift or just use service brakes when going downhill, you can lose control and cause injury and property damage. To help avoid loss of control, use a combination of downshifting, braking, and other retarding devices. Downshifting to a lower transmission range increases engine braking and helps you to maintain control. The transmission has a feature to prevent automatic upshifting above the lower range selected. However, during downhill operation, if engine governed speed is exceeded in the lower range, the transmission may upshift to the next higher range. This will reduce braking and could cause a loss of control. Apply the vehicle brakes or other retarding device to prevent exceeding engine governed speed in the lower range selected.</p>
<b>2-4</b>	<p>Occasionally, the road, load, or traffic conditions will make it desirable to restrict the automatic shifting to a lower range. (When conditions improve, return the selector to the normal <b>D</b> (Drive) position.) The positions also provide a greater engine braking for going down grades (the lower the range, the greater the braking affect).</p>
<b>2-3</b>	

# RANGE SELECTION — HT 750DR, HT 750DR DB *(cont'd)*

<b>2</b>	Use this position for vehicle speed control up or down steep grades or for other undesirable road conditions.
<b>1</b>	This is the creeper range — select this for off-highway operation. Use the creeper for pulling through mud or snow. This range provides the greatest tractive advantage. It is not recommended that 1–2 or 2–1 shifts be made while the vehicle is moving.

## DRIVING TIPS



### THROTTLE CONTROL

The position of the throttle influences the automatic shifting. At wide open throttle, the transmission will upshift automatically near the governed speed of the engine. At part throttle, shifts will occur at a lower engine speed. When modulated lockup is provided, closed-throttle operation delays the release of the lockup clutch to provide additional engine braking at lower vehicle speeds.



**CAUTION:** Never shift from **N** (Neutral) to **D** (Drive) or **N** (Neutral) to **R** (Reverse) at engine speeds above idle. The vehicle will lurch forward or rearward and the transmission can be damaged.

### DOWNSHIFT INHIBIT FEATURE

The transmission hydraulic system will inhibit a shift into any range at a speed that will cause engine overspeed. Any lower, forward range may be selected at any time, but the actual engagement will not occur until road speed is reduced; downshifting is progressive as road speed decreases. The inhibit effect will cause downshifts to occur at slightly higher speeds than normal automatic downshifts.

### OPERATING IN COLD WEATHER



**CAUTION:** Disregarding minimum fluid temperature limits can result in transmission malfunction or reduced transmission life.

Refer to Table 2 on Page 31 for the minimum fluid temperatures at which the transmission may be safely operated in a forward or reverse range. When ambient temperature is below the minimum fluid temperature limit and the transmission is cold, preheat is required. If auxiliary heating equipment is not available, run the equipment or vehicle with the transmission in neutral for a minimum of 20 minutes before attempting range operation.

## USING THE ENGINE FOR DOWNHILL BRAKING TO SLOW THE VEHICLE OR EQUIPMENT



**WARNING:** The transmission incorporates a hold feature to prohibit upshifting above the range selected during normal driving. For downhill operation, select a lower transmission range. However, if engine governed speed is exceeded in the held range, the transmission may upshift to the next higher range and damaging engine overspeed is a possibility. Use the vehicle brakes or retarder to prevent exceeding engine governed speed in the held range.

To use the engine as a braking force, select the next lower range. If the vehicle is exceeding the maximum speed for the lower range, use the service brakes and/or hydraulic retarder to slow the vehicle so that the lower range is obtained.



**NOTE:** Transmissions that do not have a lockup clutch (AT 540, AT 542, AT 545) provide less engine braking than units which have a lockup clutch. Downhill speed control for non-lockup units without a retarder must rely on the service brakes.

## USING THE HYDRAULIC RETARDER



**WARNING:** Do not use the retarder during inclement weather or when road surfaces are slippery. De-energize the retarder at the master control switch.



**CAUTION:** Observe the following cautions when driving a vehicle equipped with an input or output retarder:

- APPLY AND OPERATE THE RETARDER WITH ENGINE AT CLOSED THROTTLE ONLY.
- OBSERVE TRANSMISSION AND ENGINE TEMPERATURE LIMITS AT ALL TIMES. Select the lowest possible transmission range to increase the cooling system capacity and total retardation available.
- OBSERVE THE RETARDER “ALERT LIGHT” to ensure that the vehicle control system is functioning properly.
- DO NOT OPERATE THE INPUT OR OUTPUT RETARDER SIMULTANEOUSLY WITH AN ENGINE EXHAUST BRAKE. Extreme torque loads can be produced in the range section, damaging the transmission.
- In the event of OVERHEATING, DECREASE USE OF THE HYDRAULIC RETARDER; USE THE SERVICE BRAKES.

Hydraulic retarders are available on some models of the AT 500, MT 600, and HT 700 Series transmissions. The AT 500 retarder and the MT 643R input retarder are located between the torque converter and the transmission gearing. The MT 600 output retarder is installed on the rear of the transmission in place of the output housing. The HT 700 retarder is installed between the torque converter and the transmission gearing. The function of the retarder is to provide auxiliary retardation.

The AT 500 Series retarder is available on models without lockup or PTO provision. The MT 643R retarder is available on models with lockup but without PTO provision. The retarder is an integral part of the transmission which slows the vehicle by applying a hydraulic braking force. Retardation and cooling are greatest at high input (engine) speeds. Maintain high input speed by preselecting a lower range. The external retarder controls (OEM-furnished) consist of a master switch and typical options shown in Table 1. External retarder controls apply the retarder at the 50 percent or at the 100 percent level. External controls are also required to automatically turn off the retarder in first range or when the vehicle anti-lock brake system is activated. External controls also provide a signal to the modulator control. The signal causes downshifts to occur at a higher speed when the retarder is operating than would normally occur during closed throttle operation.

**Table 1. Typical AT/MT Input Retarder Controls**

<b>Type</b>	<b>Description</b>	<b>Amount Of Application</b>
Manual	Manual 3-Position Switch	0%, 50%, Or 100%
Automatic	12V or 24V Signal When Closed Throttle Is Sensed	50% Or 100%
	12V or 24V Signal When Brake Pedal Is Applied	50% Or 100%
Combination	Manual 2-Position Switch and Closed Throttle Sensor	50% From One Device, 100% From The Second Device
	Manual 2-Position Switch And Brake Pedal Apply	50% From Switch, 100% From Brake Pedal
	Closed Throttle Sensor Plus Brake Apply Sensor	50% From Closed Throttle, 100% When Brake Applied

The MT 600 Series output retarder is mounted on the rear of the transmission as an integral part of the transmission and provides your vehicle with an auxiliary retardation system to slow the vehicle. The unit combines hydraulic and friction clutch retardation capabilities. In many applications, the retarder is applied in conjunction with the service brakes.



The HT 700 Series retarder, located between the torque converter and the transmission gearing, provides hydraulic retardation capabilities to slow the vehicle. Maximum retarder effect in this series occurs at high input speed. Selecting a lower hold range position when using this type retarder is recommended for maximum effect.

Depending on the vehicle retarder apply system used, partial retarder application is available when maximum application is not needed.

## AUXILIARY TRANSMISSION

Select the desired auxiliary gear ratio while the vehicle is stopped. Do not shift the auxiliary transmission while the vehicle is moving.

## TWO-SPEED AXLE

The two-speed axle may be shifted from low to high or high to low while the vehicle is moving without damaging the transmission. However, the axle or vehicle manufacturer's recommendations should be followed for shifting the axle. It is recommended that axle shifts be made with the transmission in the highest range to prevent a transmission range shift from coinciding with an axle shift.

## TOWING OR PUSHING



**CAUTION:** Failure to disconnect the driveline or remove the axle shafts before towing or pushing can cause serious transmission damage.

The engine cannot be started by towing or pushing. Before towing or pushing a vehicle, disconnect the driveline or lift the drive wheels off the road. If the vehicle is a motor coach, remove the axle shafts from the drive wheels. When the axle shafts are removed, be sure to cover the wheel openings to prevent loss of lubricant and entry of dust and dirt. An auxiliary air supply will usually be required to actuate the vehicle brake system.

## PARKING BRAKE

On a vehicle with no **P** (Park) position on the transmission shift selector, always put the selector in **N** (Neutral) and apply the parking brake (or emergency brake if the vehicle is not equipped with a parking brake) to hold the vehicle when it is unattended.

# DRIVING ON ICE OR SNOW



**WARNING:** Do not use the retarder during inclement weather or when road surfaces are slippery. De-energize the retarder at the master control switch.

The ALLISON AUTOMATIC continuously provides proper balance between required power and good traction. The driver can have better control of his vehicle because of this smooth, constant flow of power through the drivetrain. When driving on ice or snow, any acceleration or deceleration should be made gradually.

# ROCKING OUT



**CAUTION:** DO NOT make neutral-to-range or directional shift changes when engine rpm is above idle. Failure to return to idle will subject the transmission to excessive shock loads which could cause clutch and/or shaft damage. Also, do not allow the transmission to overheat while rocking out.

If the vehicle is stuck in deep sand, snow, or mud, it may be possible to “rock” it out. Shift to **D** (Drive) and apply steady, light throttle (never full throttle). When the vehicle has rocked forward as far as it will go, apply and hold the vehicle service brakes. Allow the engine to return to idle; then select **R** (Reverse). Apply a steady, light throttle and allow the vehicle to rock in **R** (Reverse) as far as it will go. Again apply and hold the service brakes and allow the engine to return to idle. This procedure may be repeated in **D** (Drive) and **R** (Reverse) if each directional shift continues to move the vehicle a greater distance. Never make neutral-to-range or directional shift changes when the engine rpm is above idle.

# TEMPERATURES

The transmission fluid temperature is indicated in some vehicles by a gauge which usually indicates oil temperature to the cooler (converter out). In some vehicles the only temperature indication is the engine coolant temperature indicator.

Some important transmission temperatures are shown in the following table.

Sump Fluid, Minimum Continuous	100°F (40°C)
Sump Fluid, Typical Continuous	200°F (93°C)
Converter Out Fluid, Maximum	300°F (149°C)
Retarder Out Fluid, Maximum	330°F (165°C)
Sump Fluid, Maximum	250°F (121°C)

The transmission must never be operated above any of the maximum temperatures shown in the table.

Extended operations at low vehicle speeds with the engine at full throttle or during extended use of the hydraulic retarder can cause excessively high fluid temperatures in the transmission. These temperatures may tend to overheat the engine cooling system as well as cause possible transmission damage.



**CAUTION:** Never operate the engine for more than 30 seconds at full throttle with the transmission in range and the output stalled. Prolonged operation of this type will cause the transmission fluid temperature to become excessively high and will result in severe overheat damage to the transmission.

- If excessive temperature is indicated by the engine coolant temperature gauge, stop the vehicle and determine the cause as soon as safely possible. If the cooling system appears to be functioning properly, the transmission may be overheated. Shift to **N** (Neutral) and accelerate the engine to 1200–1500 rpm. If the transmission is the cause, this should reduce the engine coolant temperature to operating level within a short time.
- If excessive temperature is indicated by the transmission fluid temperature gauge, stop the vehicle as soon as safely possible and shift to **N** (Neutral). Accelerate the engine to 1200–1500 rpm and allow the temperature to return to normal (2 or 3 minutes) before resuming operation.



**NOTE:** When overheating occurs during retarder operation, do the following.

- For output retarders, reduce retarder usage.
- For input retarders, reduce retarder usage and increase the retarder's cooling ability. For AT 500(R) or MT 643R input retarders, overheating can be reduced by using 50 percent apply instead of 100 percent.
- If the transmission overheats during normal operation, check the fluid level in the transmission. (Refer to the fluid check procedure found on Page 27 in the Care and Maintenance section of this handbook.)
- If high temperature in either the engine or transmission persists, stop the engine and have the overheating condition investigated by maintenance personnel.

# POWER TAKEOFF OPERATION



## ENGINE-DRIVEN PTO

Some models provide PTO mountings on the top and side of the torque converter housing. The type of PTO installed will determine the operating procedures.

If the PTO driven gear is in constant mesh with the drive gear in the converter housing, and a friction clutch is used to connect the PTO load, the PTO can be engaged or disengaged at any time (except at engine speeds that exceed drive speed limits imposed on the driven equipment). If the PTO is engaged by either a sliding gear or dog clutch, the vehicle engine must be stopped to engage or disengage the PTO. Do not exceed the drive speed limits of the driven equipment.

## CONVERTER-DRIVEN PTO

A power takeoff may be mounted onto the mounting pad on the side of the transmission. The PTO drive gear is turbine driven and thus provides infinitely variable speeds. The power takeoff can be operated when the vehicle is either moving or stopped. However, on some applications the PTO can be operated only when the transmission is in neutral.



**CAUTION:** Always allow the engine to return to idle speed before shifting to a forward or reverse range after operating the PTO with the transmission in neutral. Failure to return to idle will subject the transmission to excessive shock loads which could cause clutch and/or shaft damage.

To operate the power takeoff, follow these instructions:

- Stop the vehicle, set the brakes, and idle the engine.
- Place the shift selector in a drive range.



**CAUTION:** Never engage the PTO by clashing the gear teeth. This may damage the PTO unit and the PTO drive gear teeth. Stop clashing by releasing the vehicle brakes and allowing the vehicle to move slightly or by moving the shift selector from a drive range to **N** (Neutral) and back to a drive range.

- Engage the PTO.

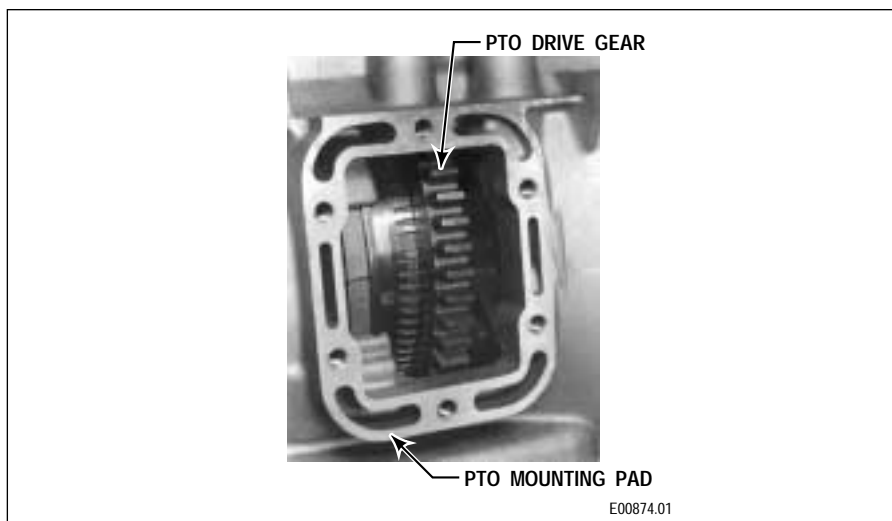

**Typical PTO Drive Gear And Mounting Pad**



**CAUTION:** Do not exceed the speed limits imposed on the driven equipment during operation of the PTO.

- If the power takeoff will be operated while the vehicle is stopped, set the parking brake, shift the transmission to **N** (Neutral), and depress the accelerator as required. Disengage the PTO after returning the engine speed to idle and stopping the PTO-driven equipment.
- If the power takeoff will be operated while the vehicle is moving, simply select the desired range and depress the accelerator as required. However, the speed of the power takeoff during this type of operation will be affected by the ranges selected and the speed of the vehicle.
- To disengage the power takeoff, stop the vehicle, idle the engine, and set the brake. Place the shift selector in a drive range, stop the PTO-driven equipment, and disengage the power takeoff. Return the transmission shift selector to **N** (Neutral).

# CARE AND MAINTENANCE



## PERIODIC INSPECTIONS

The ALLISON AUTOMATIC requires minimum maintenance. Careful attention to the fluid level, selector linkage, and throttle (modulator) linkage is most important.

For easier inspection, the transmission should be kept clean. Report any abnormal condition to your maintenance personnel.

Inspect the transmission for the following.

- loose bolts (transmission and mounting components)
- transmission fluid leaks\*
- shift linkage freely positioned by transmission detent
- for mechanical modulator valve actuators:
  - full (and ease of) movement of mechanical modulator linkage
  - vacuum or air line and modulator for leaks
- for electrical modulator valve actuators: proper connections, wire routing and operation
- damaged or loose hydraulic lines
- damaged or loose electrical harnesses
- worn or frayed electrical connections
- driveline U-joints and slip fittings
- speedometer cable and fittings
- PTO linkage and driveline

Inspect the transmission fluid for the following.

- Check transmission and dropbox fluid levels regularly. Once consistent daily hot level checks have been established and daily inspection shows no sign of transmission leakage, less frequent checks could be made.
- Check the engine cooling system occasionally for evidence of transmission fluid, which would indicate a faulty cooler.

---

\* Transmission fluid leaks require immediate attention.

# PREVENT MAJOR PROBLEMS

Minor problems can be kept from becoming major problems if you **notify maintenance personnel** when any of these conditions occur:

- Overheating
- Shifting feels odd
- Transmission leaks fluid
- Unusual transmission-related sounds (changes in sound level caused by normal engine thermostatic fan cycling while climbing a long grade with a heavy load have been mistaken for unusual transmission-related sounds).

# IMPORTANCE OF PROPER FLUID LEVEL

Because the transmission fluid cools, lubricates, and transmits hydraulic power, it is important that the proper fluid level be maintained at all times. If the fluid level is too low, the converter and clutches will not receive an adequate supply of fluid. If the level is too high, the fluid will aerate, the transmission will overheat, and fluid may be expelled through the breather or dipstick tube.

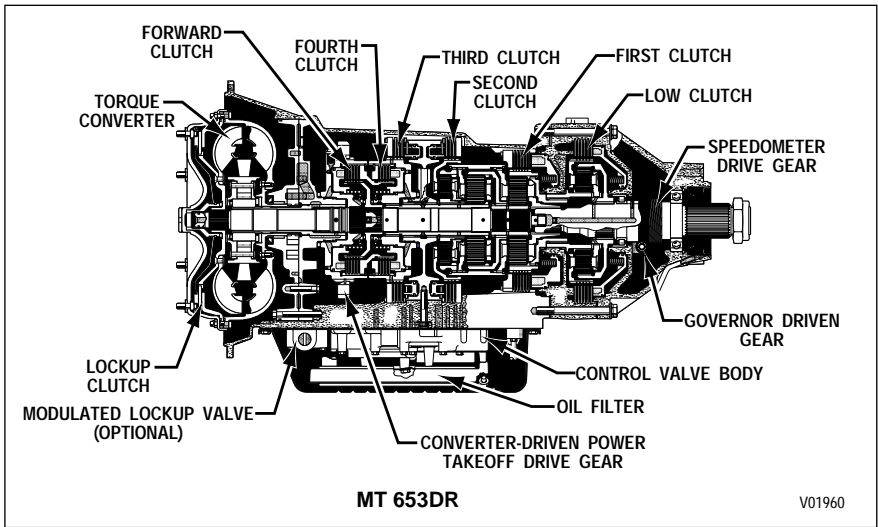

**Transmission Cross-Section Showing Internal Components**

# TRANSMISSION FLUID CHECK PROCEDURE



**WARNING:** Take the following precautions so that unexpected, possible sudden vehicle movement is avoided. Whenever it becomes necessary to leave the vehicle, even momentarily, while the engine is running, place the transmission shift selector in **N** (Neutral) or **P** (Park), set the parking brake and/or emergency brakes and chock the wheels.



**CAUTION:** Dirt and foreign matter must not be permitted to enter the fluid system. It can cause valves to stick, cause undue wear of transmission parts, or clog passages.



## NOTE:

- Always check the transmission fluid level a minimum of two times. Consistency is important in maintaining accuracy. If inconsistent readings persist, check the transmission breather and the vent hole in the dipstick fill tube to ensure they are clean and free of debris. The vent hole is located on the underside of the fill tube just below the seal of the dipstick cap.
- Transmissions equipped with a transfer gear housing (dropbox) contain two separate hydraulic systems: the transmission system and the dropbox system. Each system uses different transmission fluid and must be checked independently.

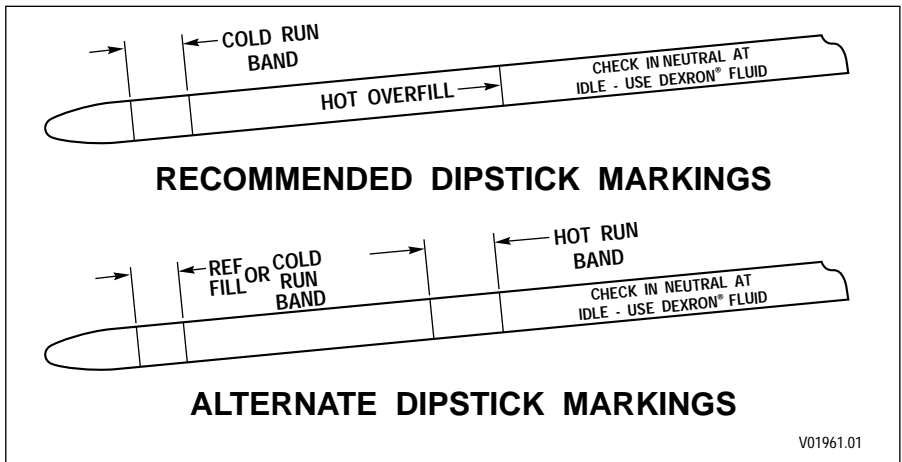

V01961.01

Typical Dipstick Markings



Check the fluid level by the following procedures and record any abnormal fluid level, milky appearance, or any trace of coolant in the fluid on your maintenance records.

### Cold Check



**NOTE:** The only purpose of the Cold Check is to determine if the transmission has enough fluid to be safely operated until a Hot Check can be made.

- Park the vehicle on a level surface, set the parking brake and/or emergency brakes, and chock the vehicle wheels.
- Run the engine at 1000–1500 rpm for 1 minute to purge air from the system. Return engine to idle, then shift to **D** (Drive) and then to **R** (Reverse) to fill the hydraulic circuits with fluid. Then shift to **N** (Neutral) or **P** (Park) and allow the engine to idle (500–800 rpm). A cold check should be made when the sump fluid temperature is 60–120°F (16–49°C). This temperature typically occurs within the first ten minutes of operation during initial start-up.



**CAUTION:** The fluid level rises as sump temperature increases. **DO NOT** fill above the COLD RUN band if the transmission fluid is below normal operating temperature.



**NOTE:** To ensure an accurate cold check, operate the transmission until the sump fluid temperature is 60–120°F (16–49°C). This temperature is usually reached within the first ten minutes of operation from initial start-up.

- Clean around the end of the fill tube before removing the dipstick. Wipe the dipstick clean and check the fluid level. If the fluid on the dipstick is within the COLD RUN or REF FILL band, the level is satisfactory for operating the transmission until the fluid is hot enough to perform a HOT RUN check. If the fluid level is not within the COLD RUN or REF FILL band, add or drain fluid as necessary to bring the level to the middle of the band.
- Perform a hot check at the first opportunity.

## Hot Check



**NOTE:** The fluid level rises as the temperature increases. To ensure an accurate check, operate the transmission until the sump fluid temperature is 160–200°F (71–93°C); converter-out temperature is 180–220°F (82–104°C). If a transmission temperature gauge is not present, check fluid level when the engine water temperature gauge has stabilized and the transmission has been operated under load for at least one hour.

- Shift to **D** (Drive) and then to **R** (Reverse) to fill the hydraulic circuits with fluid.
- Park the vehicle on a level surface and shift to **N** (Neutral) or **P** (Park). Set the parking brake and/or emergency brakes and chock the vehicle wheels. Allow the engine to idle (500–800 rpm).
- After wiping the dipstick clean, check the fluid level. The safe operating range is anywhere between the FULL and ADD lines, within the HOT RUN band, or below the HOT OVERFULL mark and above the COLD RUN band.
- If the fluid level is outside of these parameters, raise or lower the fluid level to bring it within the correct markings on the dipstick. Approximately one quart (one liter) of fluid is required to raise the level from the bottom to the top of the band.

## DROPBOX FLUID CHECK PROCEDURE

- Bring the dropbox to operating temperature.
- Park the vehicle on level ground, set the parking brake, and turn off the engine.
- If a level indicator (fill tube) is used, remove the fill tube plug and check the fluid. Full capacity is indicated when the fluid is at the top of the fill tube. Maintain a full capacity by adding the required amount of fluid.
- If a dipstick is used, wipe the dipstick clean. Insert the dipstick into the filler tube, remove the dipstick and check the level. The safe level is any level between the Full and Add marks on the dipstick. If the fluid level is on or below the Add mark, add fluid as required.

## KEEPING FLUID CLEAN



**CAUTION:** Do not use containers or fillers for transmission fluid that have been used to handle any antifreeze or engine coolant solution. Antifreeze and coolant solutions contain ethylene glycol which, if introduced into the transmission, can cause the clutch plates to fail.

It is absolutely necessary that the fluid put into the transmission be clean. Fluid must be handled in clean containers, fillers, etc., to prevent foreign material from entering the transmission. Lay dipstick in a clean place while filling the transmission.

## RECOMMENDED AUTOMATIC TRANSMISSION FLUID AND VISCOSITY GRADE — NON-MT 643R TRANSMISSIONS

Hydraulic fluids (oils) used in the transmission are important influences on transmission performance, reliability, and durability.

- The following transmission fluid and viscosity grades are recommended.
  - DEXRON®-III fluids for standard duty, on-highway applications
  - Type C-4 fluids (Allison approved SAE 10W or SAE 30) for severe duty and off-highway applications
  - Type C-4 SAE 30 for all applications where the ambient temperature is consistently above 95°F (35°C)
  - Type C-4 SAE 30 for dropboxes
- Some DEXRON®-III fluids are also qualified as Type C-4 fluids. To ensure the fluid is qualified for use in Allison transmissions, check for a DEXRON®-III or C-4 fluid license, or approval numbers on the container, or consult the lubricant manufacturer. Consult your Allison Transmission dealer or distributor before using other fluid types; fluid types such as Type F, and universal farm fluids may or may not be properly qualified for use in your Allison transmission.



**CAUTION:** Disregarding minimum fluid temperature limits can result in transmission malfunction or reduced transmission life.

- When choosing the optimum viscosity grade of fluid to use, duty cycle, preheat capabilities, and/or geographical location must be taken into consideration. Table 2 lists the minimum fluid temperatures at which the

transmission may be safely operated in a forward or reverse range. Operation at ambient temperatures lower than those shown will require preheating with auxiliary heating equipment or by running the vehicle with the transmission in **N** (Neutral) for a minimum of 20 minutes before attempting range operation.

## RECOMMENDED AUTOMATIC TRANSMISSION FLUID AND VISCOSITY GRADE — MT 643R TRANSMISSIONS

- Due to the added heat load from the input retarder, MT 643R transmissions require special fluid considerations. The approved fluids list is more restrictive than for non-retarder MT 643R transmissions. Also, the fluid change intervals are shorter than for non-retarder MT 643R transmissions.
- Only high quality, heavy duty diesel engine oils that are approved Allison C-4 fluids with a viscosity of either SAE 30 or SAE 15W-40 are recommended for use in MT 643R transmissions. For specific name brands, contact the local Allison Transmission Regional Office.



**CAUTION:** Disregarding minimum fluid temperature limits can result in transmission malfunction or reduced transmission life.

- Refer to Table 2 for minimum fluid temperatures at which the transmission may be safely operated with various fluids. Operation at ambient temperatures lower than those shown will require preheating with auxiliary heating equipment or by running the vehicle with the transmission in **N** (Neutral) for a minimum of 20 minutes before attempting range operation.

**Table 2. Operating Temperature Requirements for Transmission Fluid**

Viscosity Grade	Ambient Temperature Below Which Preheat Is Required	
	Fahrenheit	Celsius
SAE 0W-20	-31	-35
DEXRON®-III	-22	-30
SAE 10W	-4	-20
SAE 15W-40	5	-15
SAE 30	32	0
SAE 40	50	10

# FLUID AND FILTER CHANGE INTERVALS

Fluid and filter change frequencies are determined as follows.

- Table 3 is a general guide. The fluid must be changed whenever there is evidence of dirt or high temperature indicated by discoloration or strong odor. More frequent changes may be required when operations are subject to high levels of contamination or overheating.
- Fluid change intervals can be optimized by monitoring fluid oxidation according to the tests and limits in the Fluid Contamination section of this manual.

**Table 3. Fluid and Filter Change Intervals**

<b>Transmission Application</b>	<b>Fluid Change</b>	<b>Internal Sump Filter</b>	<b>Governor Filter</b>	<b>External Auxiliary Filter**</b>
AT 500 and 1500 Series (On-Highway) (Light-Duty) (School Bus, Motorhome, and One-Way Rental)	<b>Paper Filter:</b> 25,000 miles (40 000 km) or 12 months* <b>Brass Filter:</b> 50,000 miles (80 000 km) or 24 months*	<b>Paper Filter</b> in Shallow Pan (4.0 in.) or Deep Pan (5.3 in.): 25,000 miles (40 000 km) or 12 months* <b>Brass Screen Filter</b> in Shallow Pan (4.0 in.) or Deep Pan (5.3 in.): 50,000 miles (80 000 km) with no time limit	At overhaul	After first 5000 miles (8000 km) and at 25,000 miles (40 000 km) or 12 months, thereafter
AT 500, AT 500R, and 1500 Series (On-Highway) (Heavy-Duty)	25,000 miles (40 000 km) or 12 months*	<b>Paper Filter</b> in Shallow Pan (4.0 in.) or Deep Pan (5.3 in.): 25,000 miles (40 000 km) or 12 months* <b>Brass Screen Filter</b> in Shallow Pan (4.0 in.) or Deep Pan (5.3 in.): 50,000 miles (80 000 km) with no time limit	At overhaul	After first 5000 miles (8000 km) and at normal fluid change intervals, thereafter
AT 500 and 1500 Series (Off-Highway)	1000 hours max or 12 months*	<b>Paper Filter</b> in Shallow Pan (4.0 in.), or Deep Pan (5.3 in.): at each oil change interval <b>Brass Screen Filter</b> in Shallow Pan (4.0 in.) or Deep Pan (5.3 in.): at each oil change interval*	At overhaul	After first 500 hours and at normal oil change intervals, thereafter
MT 600 Series (On-Highway, Non-MT 643R)	25,000 miles (40 000 km) or 12 months*	<b>Paper Filter:</b> 25,000 miles (40 000 km) or 12 months* <b>Stainless Steel Screen:</b> At overhaul	25,000 miles (40 000 km) or 12 months*	After first 5000 miles (8000 km) and at normal oil change intervals, thereafter
<i>(cont'd on next page)</i>				

**Table 3. Fluid and Filter Change Intervals (cont'd)**

<b>Transmission Application</b>	<b>Fluid Change</b>	<b>Internal Sump Filter</b>	<b>Governor Filter</b>	<b>External Auxiliary Filter**</b>
MT 643R	After first 5000 miles (8000 km) then at 20,000 miles (32 000 km) or 12 months*	<b>Paper Filter:</b> At every other fluid change <b>Stainless Steel Screen:</b> At overhaul	20,000 miles (32 000 km) or 12 months*	After first 5000 miles (8000 km) then at each fluid change thereafter*
MT 600 Series (Off-Highway)	1000 hours maximum or 12 months*	<b>Paper Filter:</b> 1000 hours maximum or 12 months* <b>Stainless Steel Screen:</b> At overhaul	1000 hours maximum or 12 months*	After first 500 hours and at normal oil change intervals, thereafter
HT 700 Series (All Applications)	50,000 miles (80 000 km) or 12 months or 1200 hours*	At overhaul	At overhaul	After first 5000 miles (8000 km) and at each 25,000 miles (40 000 km) or 6 months or 600 hours, thereafter*
<p>* Whichever occurs first.</p> <p>** An Allison high-efficiency filter may be used until the Change Filter light indicates it is contaminated or until it has been in use for 3 years, whichever occurs first. No mileage restrictions apply.</p>				

## FLUID CONTAMINATION

### Examine at Fluid Change

At each fluid change, examine the fluid which is drained for evidence of dirt or engine coolant (water). A normal amount of condensation will emulsify in the fluid during operation of the transmission. However, if there is evidence of coolant, check the cooler (heat exchanger) for leakage between the cooler and fluid areas. Fluid in the coolant side of the cooler (heat exchanger) is another sign of leakage. This, however, may indicate leakage from the engine oil system.

### Metal Particles



**CAUTION:** Whenever excessive metal contamination has occurred, replacement of the cooler and replacement of all bearings within the transmission is recommended.

Metal particles in the fluid (except for the minute particles normally trapped in the filter) indicate damage has occurred in the transmission. When these particles are

found in the sump or on the magnetic plate in the bottom of the pan (if present), the transmission must be disassembled and closely inspected to find the source. Metal contamination requires complete disassembly of the transmission and cleaning of all internal and external circuits, cooler, and all other areas where the particles could lodge. (Refer to Auxiliary Filter.)

### Coolant Leakage

If engine coolant leaks into the transmission hydraulic system, take immediate action to prevent malfunction and possible serious damage. Completely disassemble, inspect, and clean the transmission. Remove all traces of the coolant and varnish deposits resulting from coolant contamination. Replace friction clutch plates contaminated with ethylene glycol.

### Fluid Analysis

Transmission protection and fluid change intervals can be optimized by transmission fluid analysis. Consult your local telephone directory for fluid analysis firms. Use one fluid analysis firm as results from various firms cannot be accurately compared. Refer to the Technicians' Guide for Automatic Transmission Fluid (SA2055) for additional information.

To optimize transmission protection, the following is the minimum series of tests required to properly monitor the condition of the transmission and transmission fluid/filter system.

- Wear Metals (ppm): Fe, Cu, Pb, Al
- Additive and Contaminant Metals (ppm): Ba, B, Ca, Mg, P, Si, Na, Zn
- Non-metal Contaminants: Fuel (% vol), Soot (% wt), Water (% vol)
- Viscosity (cSt) at 40°C (ASTM D445)
- Viscosity (cSt) at 100°C (ASTM D445)
- TAN (Total Acid Number) (ASTM D664)
- Particle Counts (particles/ml) at >5, >10, >20, >30, and >40 microns

ppm = parts per million      cSt = centiStokes      ml = milliliter

To optimize fluid change intervals, monitor fluid oxidation per the tests and limits shown in Table 4. A fluid is considered suitable for use if it meets all four limits listed in the table, regardless of color or odor. If **one** of the limits is exceeded, however, the

fluid in the subject transmission should be sampled again immediately to verify the exceeded limit. If verified, the fluid should be changed regardless of time or mileage.

**Table 4. Fluid Oxidation Measurement Limits**

Condition	Limit
Viscosity	± 25% Change From New Fluid
Carbonyl Absorbance Total Acid Number (TAN) Solids	+ 30* Change From New Fluid + 3.0** Change From New Fluid 2% By Volume Maximum
* Carbonyl absorbance units/cm ** mg of KOH required to neutralize a g of fluid	

## AUXILIARY FILTER

If a condition occurs that introduces debris into the transmission hydraulic system, a complete cleanup of the cooler and lines is recommended.



**CAUTION:** DO NOT install an auxiliary filter in the AT 500R or MT 643R primary cooler circuit. This reduces retarder effectiveness. An auxiliary filter in the secondary cooler circuit is sufficient.

Repeated cleaning and flushing may not remove all debris. For models with a retarder, replace the main cooler. For models without a retarder, install an auxiliary filter in the cooler-out line (between the cooler and transmission) if such a filter does not already exist. This filter has already been included in many recently built vehicles. This recommendation applies whether the transmission is overhauled or replaced by a new or rebuilt unit.

If any doubt exists about the cleanup of the cooler, replace the cooler.

Consult your nearest Allison Transmission dealer/distributor or the chassis OEM for detailed filter information and availability.





## CUSTOMER SERVICE

### OWNER ASSISTANCE

The satisfaction and goodwill of the owners of Allison transmissions are of primary concern to Allison Transmission Division (ATD), its distributors, and their dealers.

As an owner of an Allison transmission, you have service locations throughout the world that are eager to meet your parts and service needs with:

- Expert service by trained personnel
- Emergency service 24 hours a day in many areas
- Complete parts support
- Sales teams to help determine your transmission requirements
- Product information and literature

Normally, any situation that arises in connection with the sale, operation, or service of your transmission will be handled by the distributor or dealer in your area (check the telephone directory for the Allison Transmission service outlet nearest you).

Reference the Sales and Service Directory (SA2229) for the current listing of Allison Transmission authorized distributor and service dealers.

We recognize, however, that despite the best intentions of everyone concerned, misunderstandings may occur. To further assure your complete satisfaction, we have developed the following three-step procedure to be followed in the event a problem has not been handled satisfactorily.

**Step One — Discuss the problem with a member of management from the distributorship or dealership.** Frequently, complaints are the result of a breakdown in communication and can quickly be resolved by a member of management. If you have already discussed the problem with the Sales or Service Manager, contact the General Manager. All ATD dealers are associated with an ATD distributor. If the problem originates with a dealer, explain the matter to a management member of the distributorship with whom the dealer has his service agreement. The dealer will provide his ATD distributor's name, address, and telephone number on request.

**Step Two** — When it appears the problem cannot be resolved readily at the distributor level without additional assistance, **contact the Allison Transmission Regional Office responsible for the local distributor.** You will be assisted by a member of the Regional Service Manager’s staff, depending on the nature of your problem.

For prompt assistance, please have the following information available.

- Name and location of authorized distributor or dealer
- Type and make of equipment
- Transmission model number, serial number, and assembly number (if equipped with electronic controls, also provide the ECU assembly number)
- Transmission delivery date and accumulated miles and/or hours of operation
- Nature of problem
- Chronological summary of unit’s history

**Step Three** — If you contacted a regional office and you are still not satisfied, **present the entire matter to the Home Office by writing to the following address or calling the phone number below:**

Manager, Warranty Administration – PF9  
Allison Transmission  
P.O. Box 894  
Indianapolis, IN 46206-0894  
Phone: (317) 242-2052

The inclusion of all pertinent information will assist the Home Office in expediting the matter. If an additional review by the Home Office of all the facts involved indicates that some further action can be taken, the Regional Office will be advised.

When contacting the Regional or Home Office, please keep in mind that ultimately the problem will likely be resolved at the distributorship or dealership utilizing their facilities, equipment, and personnel. Therefore, it is suggested the above steps be followed in sequence when experiencing a problem.

Your purchase of an Allison Transmission product is greatly appreciated, and it is our sincere desire to assure complete satisfaction.

# SERVICE LITERATURE

Additional service literature is available as shown in Table 5. This service literature provides fully illustrated instructions for the operation, maintenance, service, overhaul, and parts support of your transmission. To ensure that you get maximum performance and service life from your unit, you may order publications from:

SGI, Inc.

Attn: Allison Literature Fulfillment Desk

8350 Allison Avenue

Indianapolis, IN 46268

TOLL FREE: 888-666-5799

INTERNATIONAL: 317-471-4995

**Table 5. Service Literature**

<b>Transmission Series</b>	<b>Mechanic's Tips</b>	<b>Service Manual</b>	<b>Parts Catalog</b>	<b>Technician's Guide</b>
AT 540, AT 542(N)(R)(NFE), AT 543, AT 545(N)(R), AT 1542P, AT 1545P(N)	SA1321	SA1241	SA2126 SA1235 SA3048	SA1948 SA2055*
MT 640, MT(B) 643, MT 643R MT 650, MT(B) 653	SA1357	SA1317	SA1316 SA3046	SA2009** SA2055*
MT, MTB 644, MT, MTB 647, MT, MTB 654CR	SA1357	SA1546	SA1551	SA2006◇ SA2009** SA2055*
HT 740(D)(RS)(FS), HT 747(D), HT 750CRD, HT 750DR (DB)(RS), HT 750DRI, HT 750DRD (DB), HT 754CRD, HT 754CR (RS)	SA1366	SA1270	SA1268 SA3032	SA2033 SA2055*
* Automatic Transmission Fluid ** Output Retarder Inspection/Analysis ◇ MT 654CR <i>only</i>				

# ALLISON TRANSMISSION DISTRIBUTORS

## EASTERN REGION

Atlantic Detroit Diesel-Allison, LLC  
180 Route 17 South  
Lodi, NJ 07644  
201-489-5800

Penn Detroit Diesel-Allison, Inc.  
8330 State Road  
Philadelphia, PA 19136-2986  
215-335-0500

Covington Detroit Diesel-Allison  
8015 Piedmont Triad Parkway  
Greensboro, NC 27409  
336-292-9240

Western Branch Diesel, Inc.  
3504 Shipwright Street  
Portsmouth, VA 23703  
757-484-6230

Johnson & Towers, Inc.  
2021 Briggs Road  
Mount Laurel, NJ 08054  
856-234-6990

Williams Detroit Diesel-Allison  
Southeast, Inc.  
2849 Moreland Avenue, S.E.  
Atlanta, GA 30315-0037  
404-366-1070

New England Detroit Diesel-Allison, Inc.  
90 Bay State Road  
Wakefield, MA 01880-1095  
781-246-1810

## CENTRAL REGION

Caribe Detroit Diesel-Allison  
Division of GT Corporation  
Ceramic Ind. Park, Campo Rico Ave.,  
Block C  
Carolina, Puerto Rico 00982  
787-750-5000

Inland Diesel, Inc.  
13015 West Custer Avenue  
Butler, WI 53007-0916  
262-781-7100

Central Detroit Diesel-Allison, Inc.  
9200 Liberty Drive  
Liberty, MO 64068  
816-781-8070

Interstate Detroit Diesel  
2501 East 80th Street  
Minneapolis, MN 55425  
612-854-5511

Clarke Detroit Diesel-Allison, Inc.  
3133 East Kemper Road  
Cincinnati, OH 45241  
513-771-2200

Inland Detroit Diesel-Allison, Inc.  
210 Alexandra Way  
Carol Stream, IL 60195  
630-871-1111

Florida Detroit Diesel-Allison, Inc.  
5105 Bowden Road  
Jacksonville, FL 32216  
904-737-7330

Williams Detroit Diesel-Allison  
Midwest, Inc.  
1176 Industrial Parkway, North  
Brunswick, OH 44212-2342  
330-225-7751

## SOUTHWESTERN REGION

Detroit Diesel-Allison De Mexico S.A.  
De C.V.  
Av. Ejercito Nacional #843  
Colonia Granada, Mexico D.F.  
C.P. 11520  
525-901-3057

United Engines, Inc.  
5555 West Reno Avenue  
Oklahoma City, OK 73127  
405-947-3321

Stewart & Stevenson Power, Inc.  
5840 Dahlia Street  
Commerce City, CO 80022  
303-287-7441

Stewart & Stevenson Services, Inc.  
2707 North Loop West  
Houston, TX 77008  
713-868-7700

## WESTERN REGION

Pacific Detroit Diesel-Allison Company  
7215 South 228th Street  
Kent, WA 98032  
253-854-0505

Valley Detroit Diesel-Allison, Inc.  
425 South Hacienda Boulevard  
City of Industry, CA 91745-1123  
626-333-1243

Sierra Detroit Diesel-Allison, Inc.  
1755 Adams Avenue  
San Leandro, CA 94577-1001  
510-635-8991

Williams Detroit Diesel-Allison  
Southwest, Inc.  
2602 S. 19th Avenue  
Phoenix, AZ 85009  
602-257-0561

Smith Detroit Diesel-Allison, Inc.  
250 West 3900 South  
Salt Lake City, UT 84107  
801-262-2631

## CANADIAN REGION

Detroit Diesel-Allison  
British Columbia Ltd.  
9300 - 192nd Street  
Surrey, British Columbia V4N 3R8  
604-888-1211

Midwest Detroit Diesel-Allison Ltd.  
1460 Waverley Street  
Winnipeg, Manitoba R3T OP6  
204-452-8244

Detroit Diesel-Allison Canada East  
(Div. of Integrated Power Systems Corp.)  
2997 Rue Watt  
Ste. Foy, Quebec G1X 3W1  
418-651-5371

Waterous Detroit Diesel-Allison (Div.  
of Integrated Power Systems Corp)  
10025 - 51 Avenue  
Edmonton, Alberta T6E OA8  
780-437-3550

Harper Detroit Diesel Ltd.  
10 Diesel Drive  
Toronto, Ontario M8W 2T8  
416-259-3281

# ALLISON TRANSMISSION REGIONAL OFFICES

## **EASTERN REGION**

19 Oaklynn Drive  
P. O. Box 400  
Columbus, NJ 08022-0400  
609-298-2541

## **CENTRAL REGION**

P. O. Box 894, Speed Code PF06  
Indianapolis, IN 46206  
317-242-2327

## **SOUTHWESTERN REGION**

Phone: 936-321-4248  
Fax: 936-321-4278

## **WESTERN REGION**

39465 Paseo Padre Parkway  
Suite 2400  
Fremont, CA 94538  
510-498-5208

## **CANADIAN REGION**

P. O. Box 5160, Station A  
London, Ontario N6A 4N5  
519-452-5256

